



PowerCom 2 Brochure

Elster Communications Module

The PowerCom 2 communications module was specifically designed to enable the Elster range of meters for AMR (Automated Meter Reading) purposes. The unit converts the IRDA communications string from the Elster meters, interprets the data and stores the energy parameters in non volatile memory.

POWERCOM 2	
	Elster AMR Conversion
	Interprets IRDA Output
	PowerServe Compatible

The PowerCom 2 can accommodate up to 2 Elster meters (1 when using the A1700) on 2 dedicated communications ports. Each of these ports can be individually addressed. Every PowerCom unit has its own unique ModBus address and can be addressed via the RS485 Port which can be linked into a ModBus daisy chain configuration. The PowerServe software connects to an Elster meter by addressing the specific port on the PowerCom unit via the unique ModBus address on the RS485 network. Theoretically the PowerCom unit enables the connection of 64 meters to a network before any repeaters needs to be put into the network and up to 510 meters before any address duplication will occur. The power supply has an input range of 90V AC to 230V AC, therefore it can be used in both 230V and 115V environments. The RS485 port is optically isolated and therefore protected against spikes on the network.

the PowerCom unit enables the connection of 64 meters to a network before any repeaters needs to be put into the network and up to 510 meters before any address duplication will occur. The power supply has an input range of 90V AC to 230V AC, therefore it can be used in both 230V and 115V environments. The RS485 port is optically isolated and therefore protected against spikes on the network.

Technical Information

External Connections

Picture 1 shows the location of all external connections to PowerCom, including the RS485 Port and the auxiliary supply connection. Connection between the meters and PowerCom can be established by means of any readily available 3-core wire. The use of Mylar screened twisted pair wire for all RS485 connections is strongly recommended. Ensure proper earth, screening and termination of all RS485 networks. More detail on recommended installation of the RS485 network is available on request. It is recommended that a fuse is placed inline with the auxiliary supply.

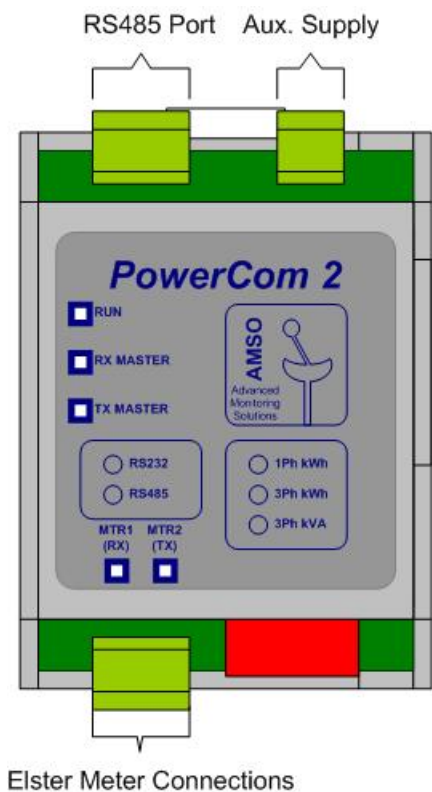

Note

Always turn off power to the PowerCom unit as well as the meter before attempting any connections..

Connecting the A100C.

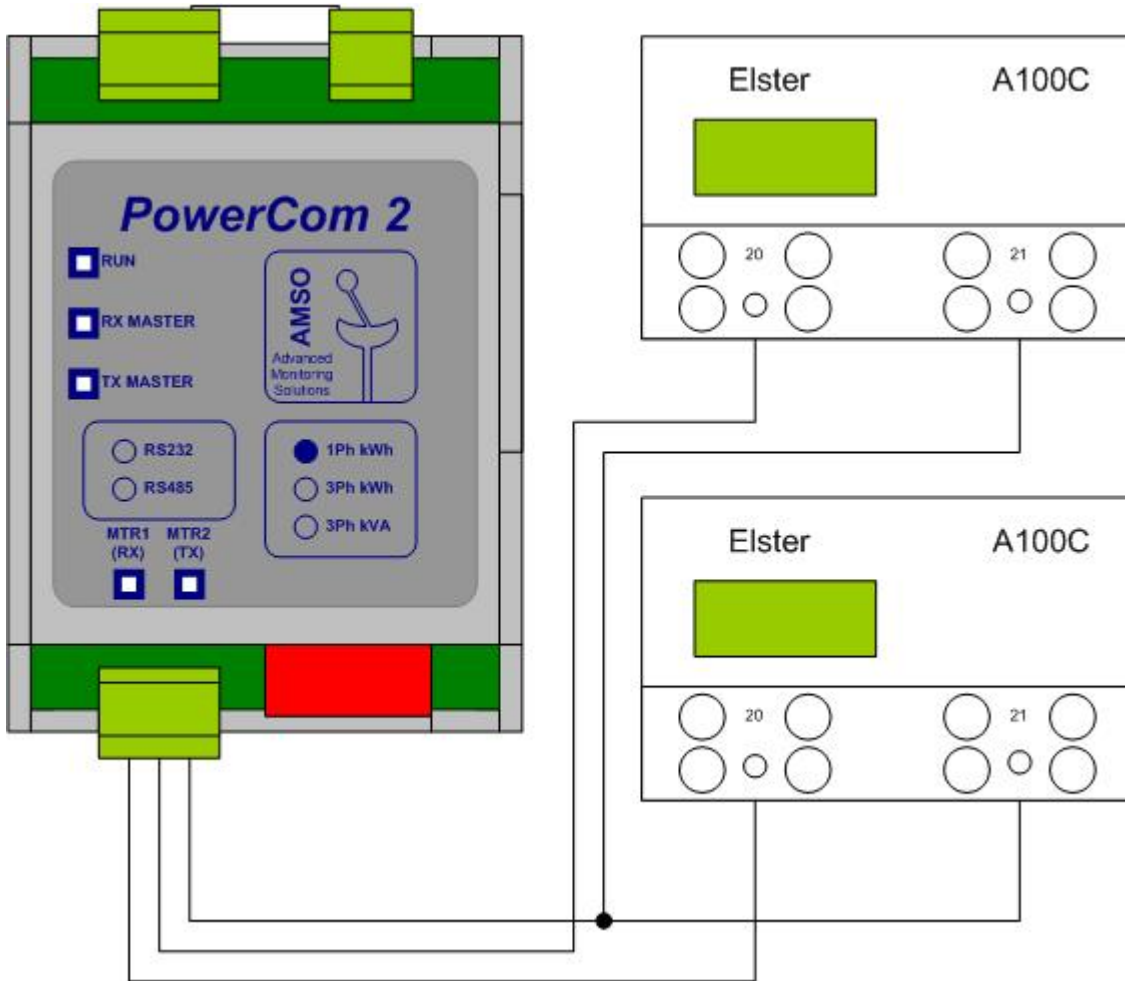

Connecting the A1100.

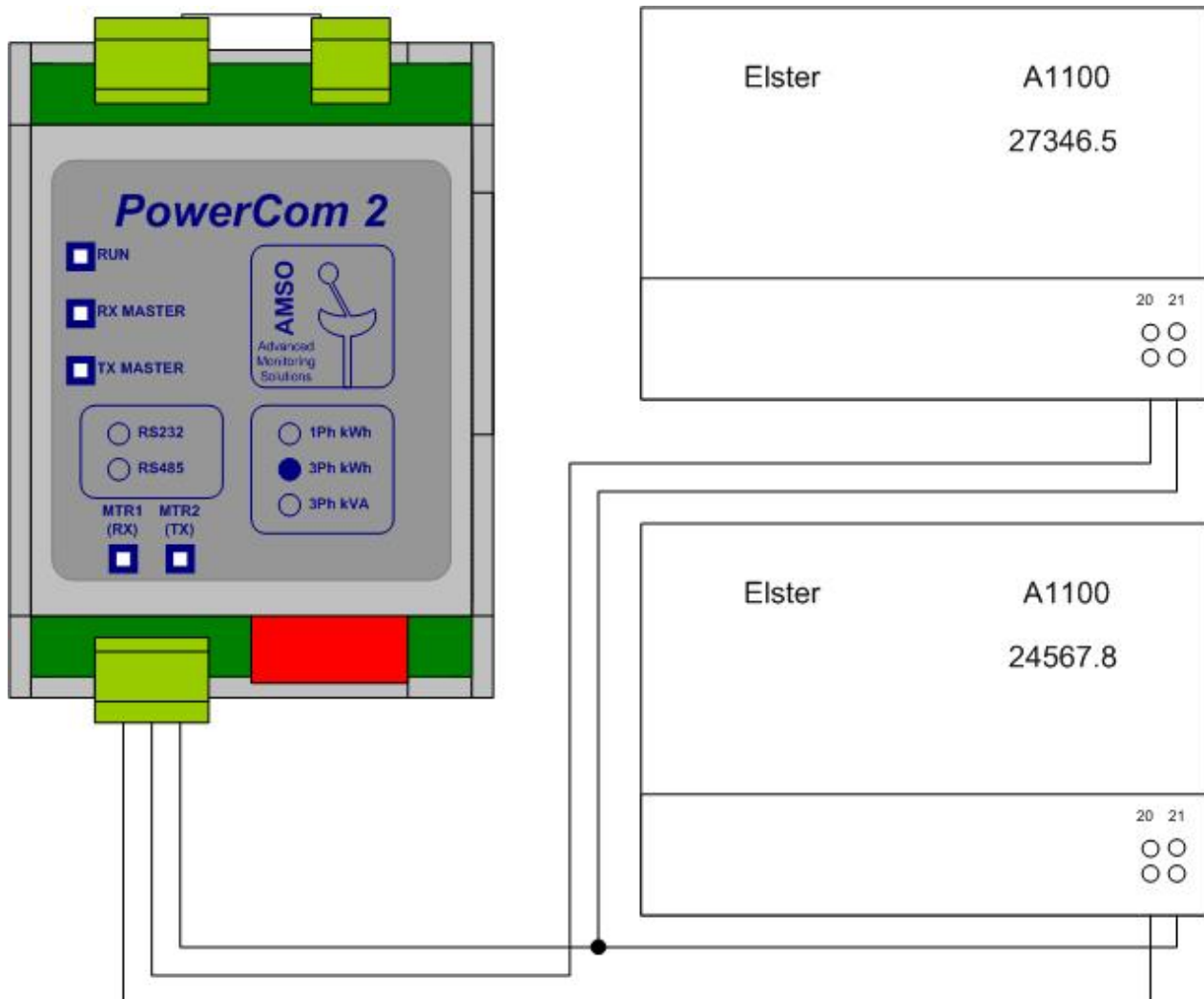

Connecting the A1700.

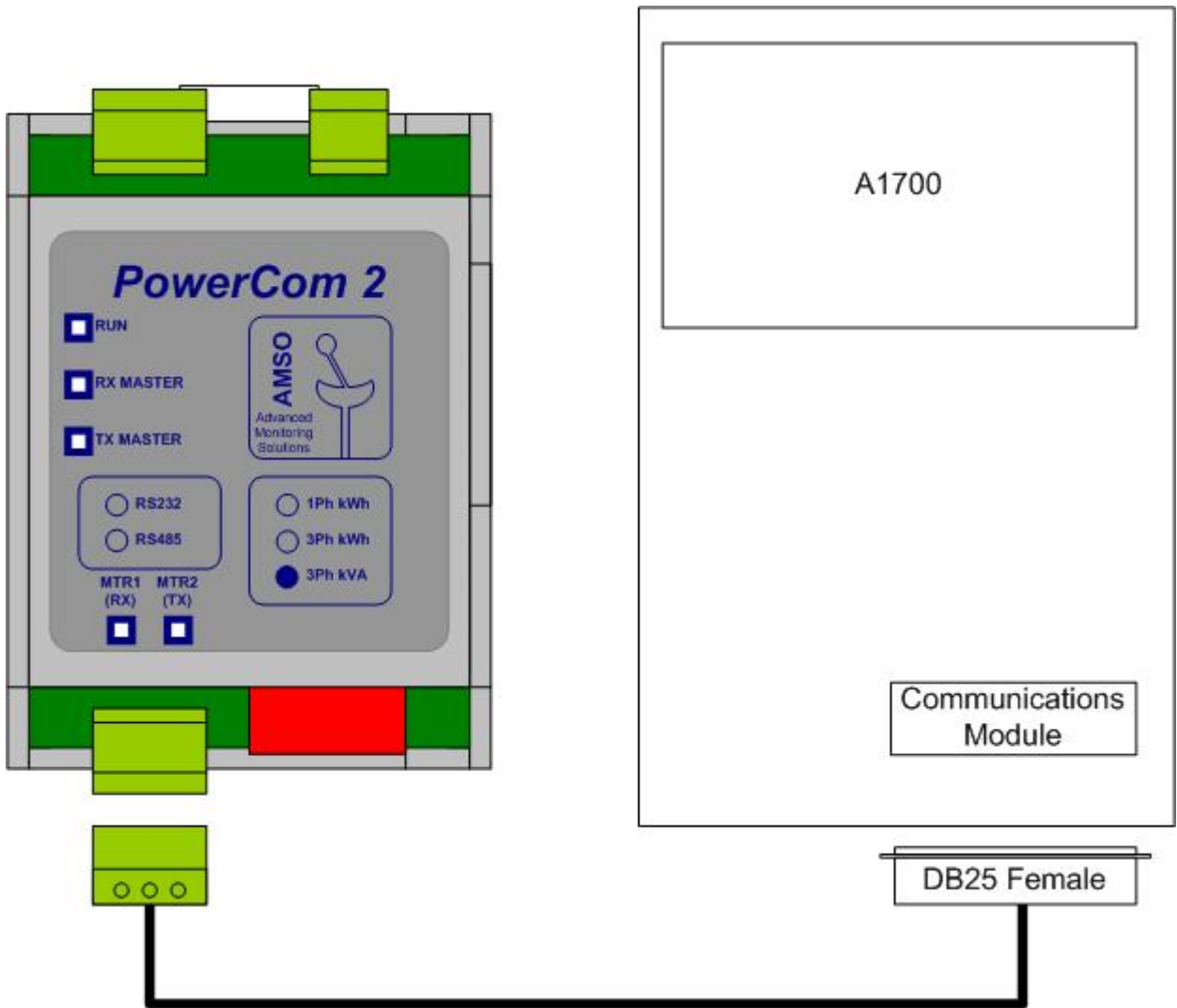

D

 Dimensions